

Casement & Pivoted Window AW1 Hardware

New Zealand made

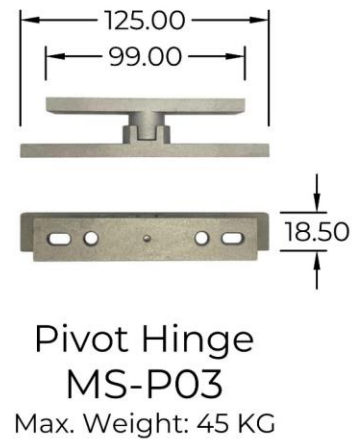

Handle (with & w/o key)
 AVON-860 / 861 / 8601 / 8611-LH / RH
 Colour: Black / Silver / White

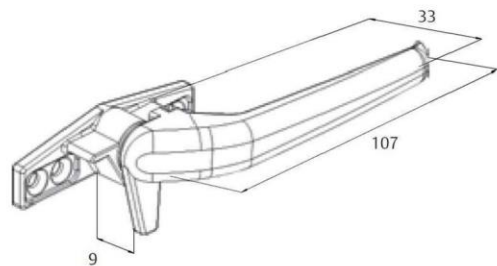
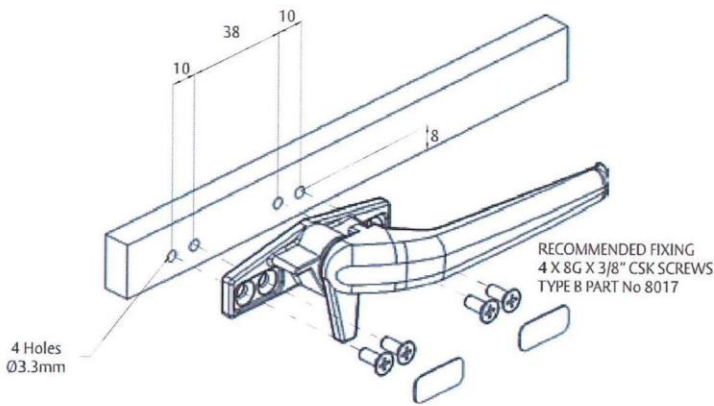

Note: Images are for illustration purposes only.

Casement Window AW3 Hardware

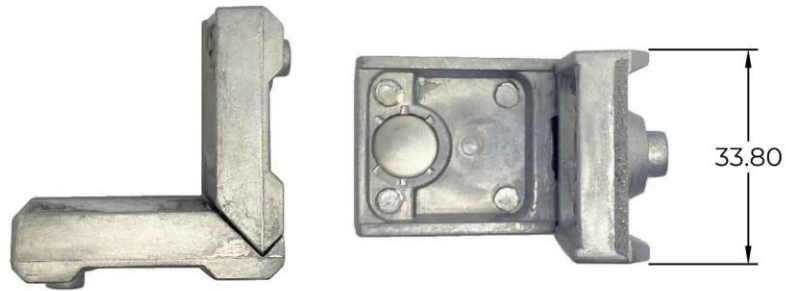

Corner Joint
 MS-331

Gasket

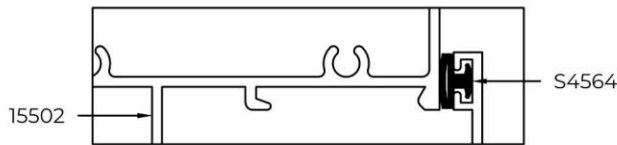

For all outer and inner profiles, transom and mullion.

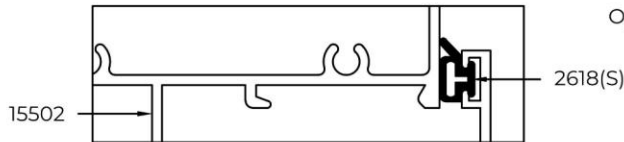

Option for all outer and inner profiles, transom and mullion.

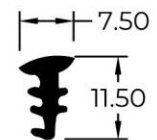
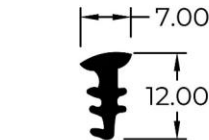
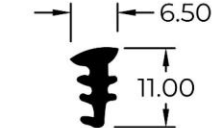
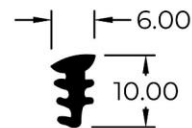
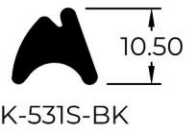

Note: Images are for illustration purposes only.

Casement Window AW3 Hardware



Friction Stay
ST - 8 / 10 / 12 / 14 / 16 / 18



Restrictor Arm
SR-12



Restrictor
PE45-A080R-SS-10

Casement Window AW6 Hardware



Steel Corner
 LE70-SC



Corner Joint
 MS-331

Handle set for Inner with Euro-groove Locking Bar



Handle (Euro Groove)
 PE45-A021.21-BK
 Colours: Black / Silver / White



Pin
 PE45-A067.25



Stainless Steel Keeper
 LK-J171-SS
 Min. 2pc



Stainless Steel Pin
 LK-J047-SS
 Min. 2pc

To match with locking bar PE010128

Handle set for Inner without Euro-groove



Handle
 LK-593
 Colours: Black / White



3 Point Locking Device
 LK-107SS104



Stainless Steel Keeper
 LK-J171-SS
 Min. 2pc

Note: Images are for illustration purposes only.